

PRODUCT SPECIFICATION

MODEL NO	HD418 MICROWAVE SERIES
INPUT	120-347V
DESCRIPTION	MICROWAVE HIGHBAY SENSOR
CERTIFICATE	UL (E496850)

120-347V BI-LEVEL DIM MICROWAVE SENSOR CONTROL (FOR HIGHBAY LIGHT)

SHENZHEN HAISEN TECHNOLOGY CO.,LTD
13th Floor, C1 Building, Songshan Lake Intelligent Valley,
Liaobu Town, Dongguan City, 523808, Guangdong.
Contact us info@haisensz.com
www.haisensz.com

Series Work of Art
All Rights Reserved by HAISEN

WRITTEN BY	夏勇
CHECKED BY (R&D)	郑登新
CONFIRMED BY (SALES)	周磊
DATE	2022.09.14

Features & Benefits

HD418 Microwave series

- 120-347V full range inMut, UL FCC certificated.
- Bi-level dimming or ON/OFF function, Highbay/lowbay version.
- Interchangeable with MIR sensor head, end-user friendly.
- Suitable for direct linear light installation, or UFO highbay with bracket (tyMe A)



Dimensions Unit:mm

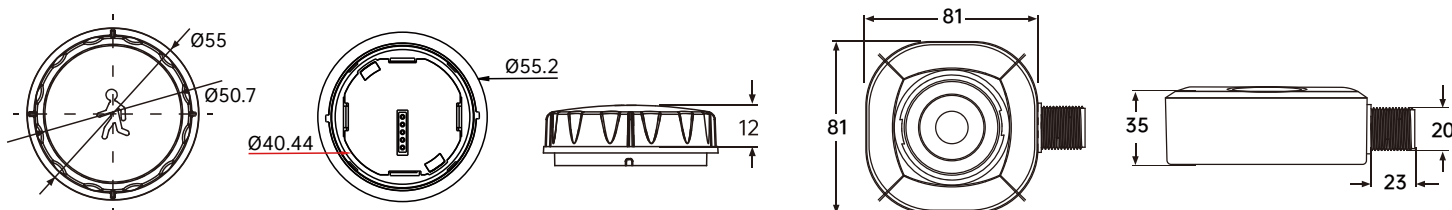

Detection Coverage

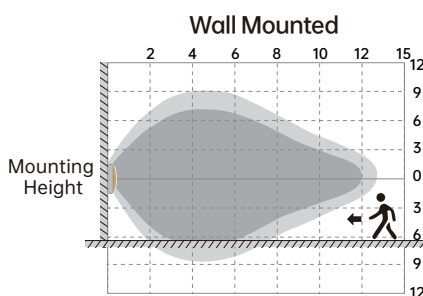
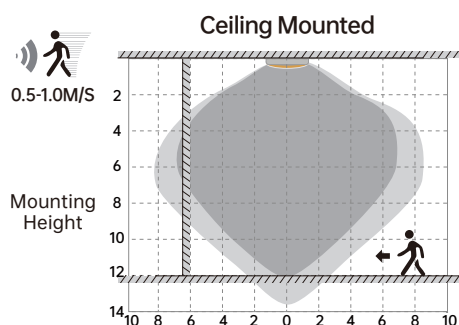

HD418 (V/S) HM

Highest mounting height is 12m

This figure indicates the maximum distance at the highest mounting height with 100% sensitivity.

Well Detected Area Possibly Detected Area

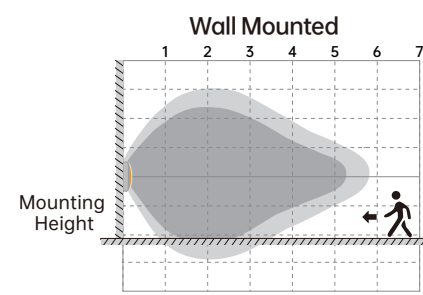
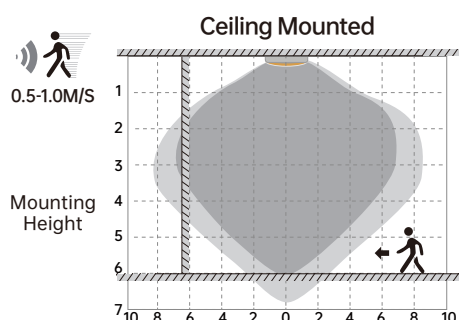

HD418 (V/S) LM

Highest mounting height is 6m

This figure indicates the maximum distance at the highest mounting height with 100% sensitivity.

Well Detected Area Possibly Detected Area

Parameters

Model NO.		HD418VHM	HD418SHM	HD418VLM	HD418SLM
MICROWAVE INFORMATION	Frequency	5.8GHz±75MHz			
	Microwave Power	<0.3mW			
	Installation Height	12m/39ft Max.		6m/19ft Max.	
	Detection Distance	≥3m/9ft			
	Warranty	5 Years			
SENSOR PARAMETER	Detection Area	25%/50%/75%/100%			
	Holdtime	5s/30s/1min/3min/5min/10min/20min/30min			
	Daylight Threshold	Disable/ 2lux/ 10lux/ 30lux/ 50lux/ 80lux/ 120lux			
	Standby Dimming Level	10%/20%/30%/50%(Not suMMorted in HD418SHM and HD418SLM)			
	Standby Period	0s/10s/30s/1min/5min/10min/30min/60min+∞ (Not suMMorted in HD418SHM and HD418SLM)			
	Default Program	Detection Area - 100% Holdtime - 5S Daylight Threshold - disable Standby Period - 0S Standby Dimming Level - 10%			
	Control	Standard Partner HD05R, the LCD screen display remote (purchase seperately)			
INPUT	Input Voltage	120-347VAC,50Hz/60Hz			
OUTPUT	Output Voltage	120-347VAC,50Hz/60Hz			
	Signal	DIM 0-10V			
	Switching Capacity	120V: 3A/400W Control Gear; 800W Ballast or Incandescent 277V: 3A/800W Control Gear; 1200W Ballast or Incandescent 347V: 1.2A/400W Control Gear; 800W Ballast or Incandescent			
	Stand-by Power	≤1W 230VAC			
ENVIRONMENT	Working Temp	-20°C~+60°C			
	Storage Temp	-40°C~+80°C Humidity: 85% (non-condensation)			
CERTIFICATE & STANDARDS	Certification	UL (E496850)			
	Environmental Requirements	In accordance with CE ROHS			
	IP Rating	IP20			
PACKAGE	Silk-Printing	Lasering			
	Packing Description	1pcs/white neutral box			
	Qty/ctn(pcs)	48			
	Net Weight/pcs (kg)	0.265			
	Gross Weight/CTN (kg)	13.5			
	Carton Size (cm)	48*48*35			

Wiring Diagram

Dimmable

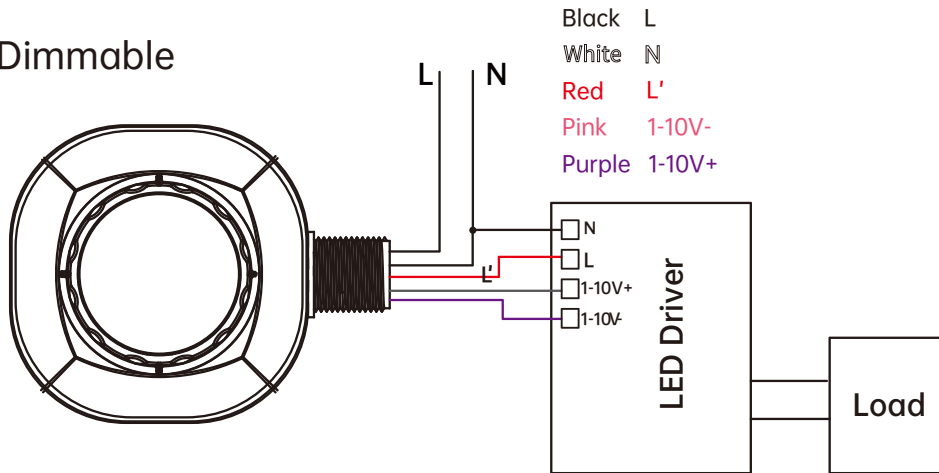

ON/OFF

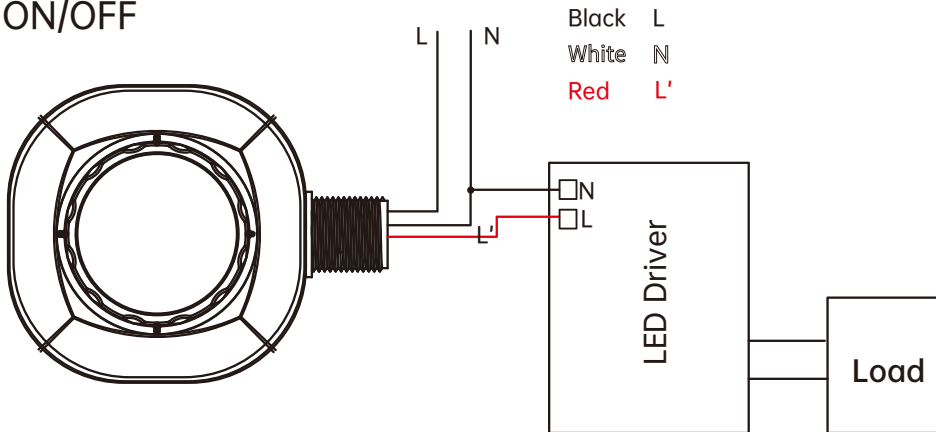

Installation

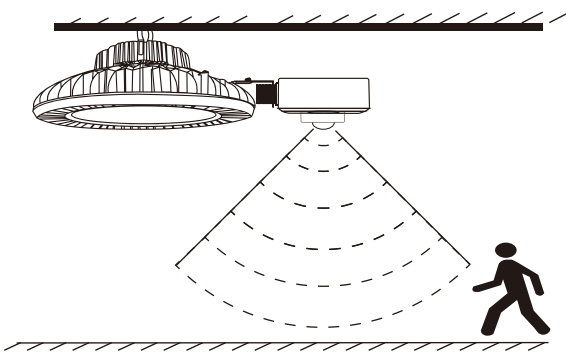

HD418SLM-A HD418VLM-A
 HD418SHM-A HD418VHM-A

With the flexible installation bracket, it can fit into UFO highbay light.

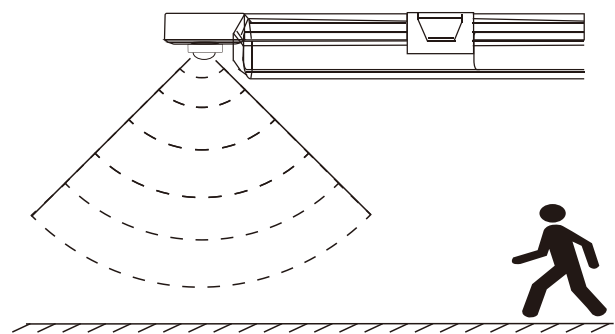

HD418SLM-B HD418VLM-B
 HD418SHM-B HD418VHM-B

With standard knock-out part, it can be installed into the linear light fixture.

Performance

1. Automatically ON/OFF function

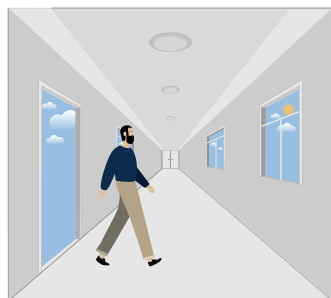

With sufficient daylight, even when motion detected, light remains OFF.

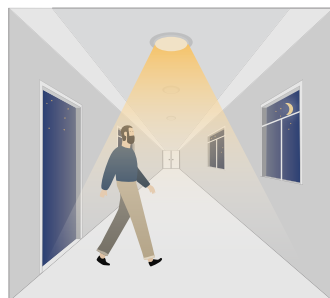

With insufficient daylight, the sensor turns light ON when motion gets detected.

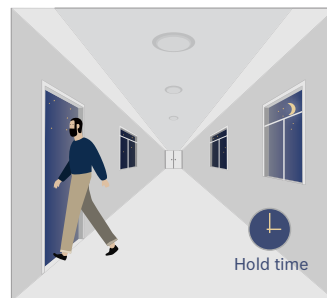

The sensor turns OFF light automatically after the holdtime when there's no motion detected.

2. Daylight Disable

When daylight threshold is preset as "disable", the sensor turns light ON when motion gets detected, and OFF after hold-time.

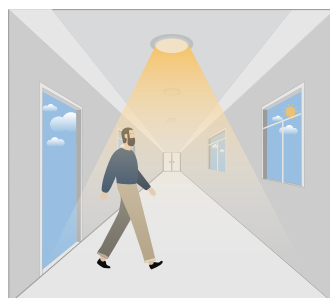

The sensor turns light ON when motion gets detected.

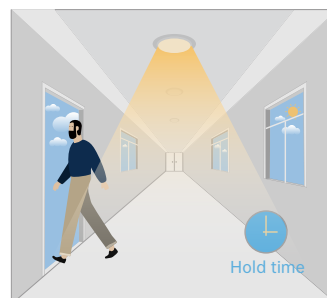

The sensor keeps light ON for holdtime period after motion leaves.

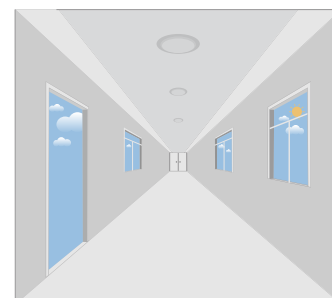

The sensor turns OFF light automatically after the holdtime.

3. Corridor Function, Bi-level Dimmable

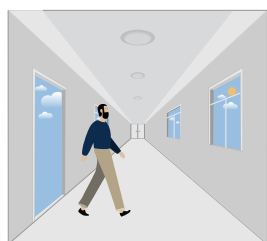

With sufficient daylight, the sensor keeps light OFF even motion gets detected.

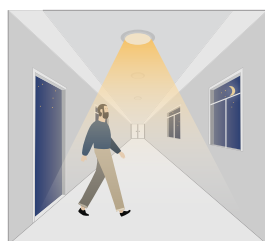

With insufficient daylight, the sensor turns light ON when motion gets detected.

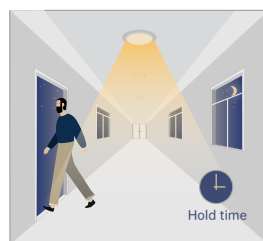

After there's no motion detected, the sensor keeps light ON 100% for holdtime.

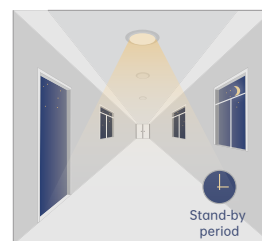

After holdtime, sensor dims light to standby dimming level for standby period.

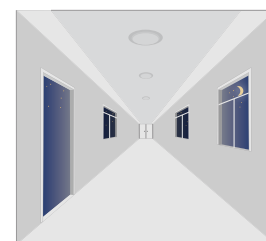

The sensor turns OFF light automatically after the standby period when there's no motion detected.



Attention

1. The sensor should be installed by qualified electrician and ensure power is OFF before installation.
2. Please read the instruction carefully before using the product and keep it well for other users to read any time.
3. We reserve the right to modify any incorrect text, image and technical parameters.
4. Any unauthorized modification is forbidden. Otherwise all guarantees will be immediately invalid.
5. Product could be optimized without prior notice.

APPLICATION NOTES

1. Suitable for indoor application, half/completely outdoor environment conditions might be captured as moving signals to trigger the sensor.
2. Suitable for ceiling mount installation, adjust sensitivity properly if it's installed on side-wall because it gets more sensitive.
3. Adjust sensitivity properly when the sensor is applied in small/narrow/metal-built/with metal spaces.
4. Microwave sensor can't be placed under/inside metal shell; Microwave module must directly face the detection area with edge lower than light fixture.
5. Keep the sensor away from vibration equipments, air-conditioning outlets, smoke extractors alike conditions to avoid unwanted trigger.
6. Keep the sensor module away from AC input and DC output to avoid high/low frequency signal interference.
7. At least 2m/6.5ft distance between microwave sensors; 1.5m/4.9ft between the sensor and other wireless devices such as routers to avoid possible radio interference.
8. Daylight testing delivered in bright day without shadow or specially designed lampshade or lens.
9. Dimming performance differs when connected to different drivers; If the driver can't completely turn OFF, sensor can't either.
10. Input power voltage must be stable with float less than 10%.
11. The first time powered ON sensor, light will be ON 100% for about 10S then dims to standby level or OFF.
12. Distance detection is delivered by testing person about 165cm in open area as reference, the result differs by size and speed of moving objects, mounting height and real-life situation.